

DEVELOPMENT OF IRON ORESSINTERING MACHINE FOR BLAST FURNACE PROCESS.

¹John Femi Akinfolarin, ²Buliaminu Kareem and ³Oladunni Oyetola Alabi

^{1,2} Department of Mechanical Engineering, Federal University of Technology Akure, PMB 704, Ondo State, Nigeria.

³ Department of Metallurgical and Materials Engineering, Federal University of Technology Akure, PMB 704, Ondo State, Nigeria, e-mail: jfakinfolarin@futa.edu.ng

ABSTRACT

There must be proper means to sinter and, agglomerated iron ore concentrate before it can be further processed in the blast furnace. A Sintering machine of 5kg capacity of agglomerated ore was designed and fabricated using mild steel material, which was locally sourced. The machine was fabricated with a combustion chamber of 30 by 30 cm and with 15cm depth. It was also lined with refractory material to reduce the chamber to the volume of 3375 cm³. However, the sintering chamber was designed to have a truncated square pyramid shape to the volume of 2150 cm³ after lining with refractory material. The design was made to utilize coke and palm kernel shell char as fuel which will be ignited to produce heat into the sintered material by suction of the heat into the agglomerated sintered ore. Tests such as tumbler index, abrasion, and porosity test were carried out on the sintered products in agreement with ASTM E276 and E389 standards. The results from the test gave a tumbler index of 70.2% and 65.7% for coke and palm kernel shells respectively. Also, abrasion index of 5.1% and 4.6% for coke and palm kernel char, and porosity of 6.8% and 6.5% for coke and palm kernel char respectively. The results from the experimental test were in agreement with other research work. Therefore, the developed iron ore sintering machine has a better efficiency of producing sinter for blast furnace operation.

Keywords: sintering system, coke, palm kernel char, test for quality of the sinters.

1. INTRODUCTION

A large number of iron ore fines was processed to supply high-quality sinters for the smooth running of blast furnaces for the production of steel. Since iron ore fine cannot be charged directly into the blast furnace, there is a need for further processing known as the agglomeration process and this process was classified into briquette, nodulization, sintering, pelleting, and vacuum extrusion process [1]. Among the listed processes for agglomeration of iron ores, a sintering technique will be required for this process, which is the process iron ore fines were agglomerated into a porous and lumpy mass by the introduction of heat produced from solid fuel known as coke [2]. More so, a lot of research had been done on this work with different modes of operation, the size of the machine, and the fuelling of the machine.

The Sintering process was invented as far back 1887 to sinter sulphide ores placed in a cylindrical container (pot sintering method) with the sintering bed being fired with dried wood and with firing operation which is from up with the aids of the burner from the top of the sintering machine and also blown with air from the bottom upwards (3). A Stationary sintering pot machine was invented with the application of pressure in the sinter pot test flow sheet and the material in the pot was ignited using liquefied petroleum gas (LPG) (4). Dwight-Lloyd system has a sintering grate which is the continuous chain of large length and width formed by the union of a series of pallet cars that make the sinter strand [7].

Machine design is the art of creating and developing a brand new or improving on an existing machine for meeting human needs or purposes [6, 8]. Also, design is an innovative, decision making and problem-solving process involving scientific knowledge. Designers generate concepts and decide dimensions for devices or products from little or little information [8].

Manufacturing is derived from the Latin word manufactures means made by hand. It involves bringing or making products out from raw material by using a different method of manufacturing processes that involve, making use of hand tools, machinery, or even computers. Therefore, it is the study of the processes required to make parts and to assemble them in machines. However, manufacturing in the area of application to engineering industries, shows how solutions can be provided to different problems related to the development of various machines produced by studying the physical, chemical, and other laws governing the manufacturing process (9).

Therefore, manufacturing technology techniques are very important in modern-day industries where machines, tools, and equipment are produced from raw or basic materials with the use of manufacturing technique process (10). Manufacturing processes can be classified into the following methods such as machining processes, casting processes powder processes, joining processes, deformation processes, heat treatment, and surface treatment processes, assembly processes, inspection and certification, packaging, warehousing, and forwarding processing (10).

However, the conceptualization and the design of iron ores sintering machine for the production of sinters for small-scale iron ore sinters producer for the smooth running of blast furnace using locally sourced materials for the production of sintering machine. More so, the machine will be designed in such a way that will accommodate any form of fuel for sintering operations and the performance of the design machine was then compared with other works.

2. MATERIALS AND METHODS

Development of sintering machine using a suction mechanism

The system was developed to produce sinters for Blast furnace processing from their deposit, using locally sourced materials for the fabrication. Design conditions were considered in the development of the Iron ores sintering system this includes:

1. The weight, melting temperature, Density, chemical composition, capacity, and quantity of the iron ore and coke in the sintering chamber for effective sintering.
2. For easy assembling and dismantling of the machine with the use of locally sourced material to enhance the possibility of replacing damaged parts with less expensive ones but equivalently satisfactory available spare – parts.
3. The strength, durability, and corrosion resistance of the selected materials. Also, the safety of the operator, production cost, and reliability of the machine without compromising for efficiency was considered.

2.1. Material Selection

The knowledge of materials selection, properties, and availability of the materials selected play a key role in the choice of different fabricated machine components or parts. The selected materials satisfy the design requirement and operation conductions of the machine. The table below shows the materials selection, criteria, and reason for the selection.

S/ N	Components	Suitable Engineering Materials	Criteria for Material Selection	Material Selected	Remarks
1	Hoppers (Combustion and sintering chamber)	Mild steel, galvanized steel, high speed steel, cast iron, stainless steel sheet	Strength, workability, lightness, cost	Mild steel	Strength and Workabili ty.
2	Screen/Sieve	Mild steel, galvanized steel, high speed steel, stainless steel sheet	Strength, ductility, corrosion resistance, workability, lightness, cost	Stainless steel	Strength, ductility and corrosion resistance.
3.	Bolt and nut	Mild steel, galvanized steel, high speed steel, cast iron, stainless steel	Strength, corrosion resistance, workability, lightness, and cost	Mild steel	Strength, rigidity.
4	Screw	Mild steel, galvanized steel, steel, cast iron, stainless steel	Strength, corrosion resistance, workability, lightness, and cost	Mild steel	Strength, rigidity.
5	Suction fan	Aluminum, Cast iron, stainless steel.	Strength, corrosion resistance, workability, lightness, and cost	Aluminu m	Strength, corrosion resistance, Lightness, Heat resistance
6	Switch	Stainless steel button and plastic button	Strength, corrosion resistance and light.	Plastics button switch	Corrosion resistance.
7	Refractories	Clay, silica sand with additives	Heat resistance, light.	Clay	Heat resistance.

2.2. Equations for designing the Machine

Machine Description

The fabricated sintering system consists of four major units which are combustion chamber, sintering chamber, suction fan compartment, and chimney (Air Duct).

1. Combustion chamber

The combustion chamber which was placed on the sintering chamber is made of mild steel, the combustion chamber accommodates the fuel (coke) which was the source of heat for sintering of Iron ore and the chamber was lagged with locally sourced refractory clay to prevent heat loss from the chamber. The volume of the combustion chamber was calculated using the equation below:

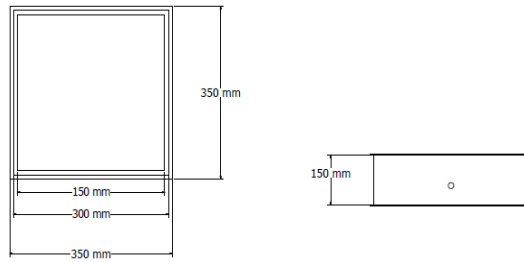

Figure 1: Combustion Chamber

$$AB = AC = BD = CD$$

Where AB = CD represents the whole sides of the cubic respectively.

$$\begin{aligned} V_{cc} &= (L \times W \times H) \\ &= (150 \times 150 \times 150) \\ &= 3375000 \text{ mm}^3 \text{ or } 3375 \text{ cm}^3 \end{aligned} \quad (1)$$

Where V_{cc} is the volume of the combustion chamber, L is the length of the combustion chamber, W is the width of the combustion chamber, H is the height of the combustion chamber.

The combustion and sintering chamber has a cubic shape and truncated square pyramid. Therefore, the volume calculated as follows;

The thickness of the lining of the shell was 75 mm was considered in the calculation. The mass of coke used, and the density of coke was essential to be known as the quantities of coke required for iron ore sintering. The coke density is 0.9 g/cm^3 , and the calculated volume of the chamber is 3375 cm^3 .

$$\begin{aligned} M_c &= D_c \times V_{cc} \\ &= 0.9 \times 3375 \\ &= 3037.5 \text{ g or } 3.0375 \text{ Kg} \end{aligned} \quad (2)$$

Hence, 3 kg of coke used to sinter Iron ore

Where M_c is the mass of coke, D_c is the density of coke, V_{cc} is the volume of the combustion chamber.

2. Sintering Chamber

The sintering chamber is under the combustion chamber that accommodates the Iron ore for sintering. The sintering chamber is lagged to prevent heat loss from chamber because heat is needed for the sintering of Iron ore. The volume of the sintering chamber was calculated.

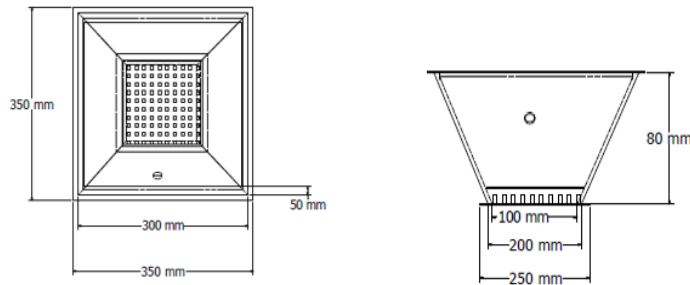

Figure 2: Sintering Chamber

$$\begin{aligned}
 V_s &= \frac{1}{3} (A^2 + AB + B^2)H & (3) \\
 &= \frac{1}{3} ((20)^2 + ((20)(10) + (10)^2)8 \\
 &= 1866700 \text{ mm}^3 \text{ or } 1866.7 \text{ Cm}^3
 \end{aligned}$$

The mass of iron ore needed also calculated using the density of iron ore which is 2.5g/cm³, and the volume of the sintering chamber calculated was 1866.7 Cm³

$$\begin{aligned}
 M_f &= (D_f \times V_s) & (4) \\
 &= 2.5 \times 1866.7 \\
 &= 4666.75 \text{ g or } 4.66675\text{kg}
 \end{aligned}$$

Calculation of Efficiency of the Sintering Machine produced

According to the Bureau of Energy Efficiency (2005), the efficiency of coke used for sintering machine can be judged by measuring the amount of fuel needed.

$$Z = \frac{Q}{D} \tag{5}$$

Z = Thermal Efficiency of sintering

Q = Heat Output

D = Heat in the fuel consumed for sintering the iron ore (Heat input)

Quantity of heat imparted (Q) (heat output) on the Iron ore can be found from

$$Q = M \times C_p (t_1 - t_2) \text{ where}$$

Q = Quantity of heat of Iron ore in k Cal.

M = Weight of Iron ore in kg

C_p = Mean specific heat of Iron ore in k Cal/kg °C

t₁ = Final temperature of Iron ore desired, °C

t₂ = Initial temperature of the Iron ore before it enters the furnace, °C

Mean specific heat of Iron ore = 0.108k Cal/kg °C

Total mass of the Iron ore (Sintering Machine) = 5kg

Total mass of coke fuel for sintering 5kg of iron ore =3kg

$t_1 = 1350^{\circ}\text{C}$

$t_2 = 35^{\circ}\text{C}$

Density of coke = $0.9\text{g}/\text{Cm}^3$

Gross calorific value (GCV) of coke = 7481.72 KCal/kg

Heat output = $MC_p(t_1 - t_2) = 3 \times 0.108 \times (1350 - 35) = 427.68 \text{ KCal}$

To calculate the Efficiency of the sintering machine by using equation 3.5 above

$$Z = \frac{Q}{D} \times 100$$

Heat in the fuel consumed for sintering the iron ore (heat input) = $3 \times 7481.72 = 22445.16$

Total of fuel needed.

$$Z = \frac{427.68 \times 100}{22445.16} = 1.91\%$$

The efficiency of 1.91% of the heat generated by the coke fuel was able to sinter the iron ore in the sintering chamber.

The Engineering drawings for Iron ore Sintering Machine

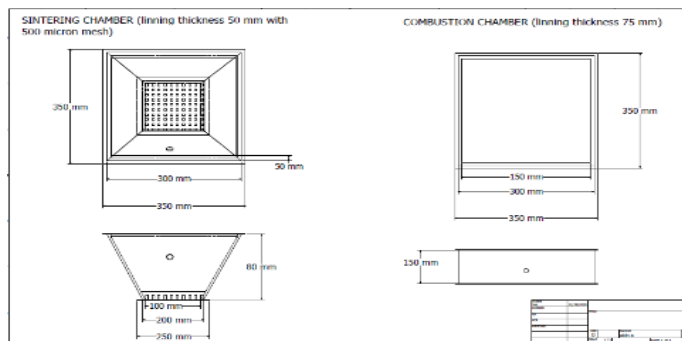

Figure 3: The Front and Plan View of the Sintering and Combustion Chamber.

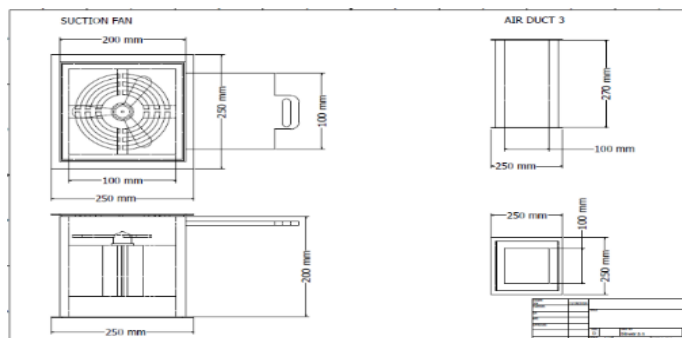

Figure 4: The Front and Plan View of the Suction Fan Compartment.

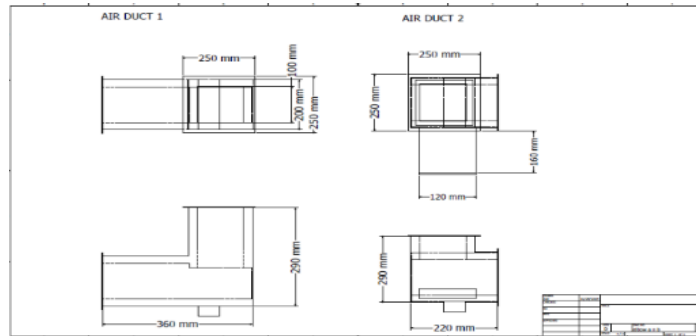

Figure 5: The Front and Plan View of the Air duct (Chimney).

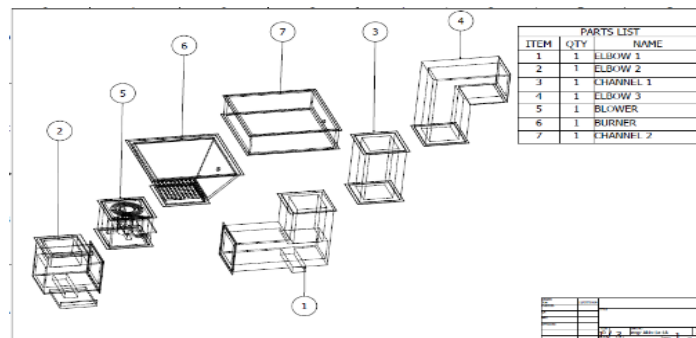

Figure 6: The Exploded Diagrams.

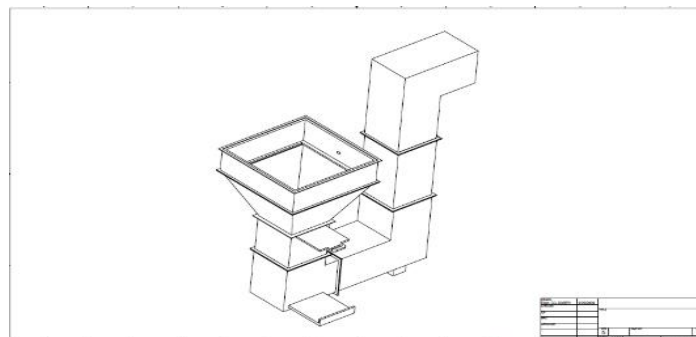







Figure 7: The Isometric Drawing of Sintering

Fabrication Processes and Assembling System

The fabrication of the Iron ore sintering system was carried out using the engineering drawing, various manufacturing processes and tools available that was suitable for each component of the machine.

The fabricated machine parts were joined together with the aid of an electric arc welding machine and assembly using suitable bolts and nuts.

Table 2: Manufacturing Processes and Tool Used.

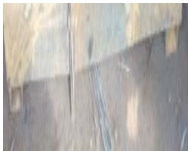
S/N	Components	Material Used	Manufacturing Process	Tools Used
1	Combustion Chamber 	Mild Steel	Cutting, Welding and Grinding	Electric Arc Welding Machine, Hack Saw And Grinding Machine.
2	Sintering Chamber 	Mild Steel	Cutting, Welding and Grinding	Electric Arc Welding Machine, Hack Saw And Grinding Machine.
3	Suction Compartment Fan 	Mild Steel	Cutting, Welding and Grinding	Electric Arc Welding Machine, Hack Saw And Grinding Machine.
4	Chimney 	Mild Steel	Cutting, Welding and Grinding	Electric Arc Welding Machine, Hack Saw And Grinding Machine.
5	Flange 	Mild Steel (Angle Bar)	Cutting, Welding and Grinding	Electric Arc Welding Machine, Hack Saw And Grinding Machine.
6	Machine Base 	Mild Steel (Square Pipe)	Cutting, Welding and Grinding	Electric Arc Welding Machine, Hack Saw And Grinding Machine.



7	<p>Lining Material</p> 	Refractory Clay	Ramming Process	Shovel, Rammer and Hand Trowel
8	<p>Assembled Machine</p> 	Mild Steel	Bolts and Nuts, Electric Arc Welding	Electric Arc Welding, Set of Spanner, Paint and Brush.



Figure 8: Fabrication of the Iron Ore Sintering System.

The principle of Operation of the Iron Ore Sintering System

The design concept of the Iron Ore Sintering System is on the principle of heat transfer by conduction. The heat was transferred from one medium to another, and the heat transferred was used to sinter the Iron ore by suction mechanism with the aid of suction fan and the lining of the system only minimize the rate of heat loss to the environment.

Recommended Maintenance practice

The system should be properly used as specified by the designer, routine maintenance should be carried out on the system, the bolts and nuts should be lubricated to prevent rusting, the electrical part of the suction fan should be checked from time to time and the lining refractory lining should be checked after been used for sometimes.

Performance Evaluation

The Iron ore sintering system has the capacity of 5Kg with two compartments which are the combustion chamber and sintering chamber. Mesh of 500 micron size aperture was placed at the base of the sintering chamber, thereafter 5Kg of iron ores of 75 micron size with $\frac{1}{4}$ of limestone (fluxing agent) of 75 micron size added to the Iron ore and mixed together thoroughly with the addition of 6 – 8% of water (as binder) and loaded into the sintering machine and 3Kg of coke was also arranged on the iron ores and the coke was

ignited with fire and the suction fan of 1 horse power (HP) with 1350 revolution per minute (RPM) was switched on to suck in air and the fire from combustion zone was progressing downward to the iron ores due to air flow through permeable bed, while thermocouple attached to sintering chamber read temperature of 1350°C which is the melting point of iron ore. The entire mass of the material was converted to porous and strong sinter. The produced sinter was allowed to cool down, crushed and screened to the recommended particle size. The undersize sinter was also recycled back to the sintering machine.

3. RESULTS AND DISCUSSION

1. Tumbler Index

Table 3:1 The result of the Tumbler Index Test using coke as source of heat.

Weight of sinter product			
	A	B	C
Initial weight of sinter	1000	1000	1000
Retained weight of sinter at +6.3mm	673	700	733
% Tumbler Index	67.3%	70%	73.3%

$$\text{Average Tumbler Index} = \frac{67.3 + 70 + 73.3}{3} = 70.2\% \quad (6)$$

Table 3:2 The result of the Tumbler Index Test using palm kernel char as source of heat

Weight of sinter product			
	A	B	C
Initial weight of sinter	1000	1000	1000
Retained weight of sinter at +6.3mm	653	657	660
% Tumbler Index	65.3%	65.7%	66.0%

$$\text{Average Tumbler Index} = \frac{63.3 + 65.7 + 66.0}{3} = 65.7\% \quad (7)$$

2. Abrasion Index

Table 3:3 The result of the Abrasion Index Test using coke as source of heat.

Weight of sinter product			
	A	B	C
Initial weight of sinter	1000	1000	1000
Retained weight of sinter at - 0.5mm	47	52	55
% Abrasion Index	4.7%	5.2%	5.5%

$$\text{Average Abrasion Index} = \frac{4.7 + 5.2 + 5.5}{3} = 5.1\% \quad (8)$$

Table 3:4 The result of the Abrasion Index Test using palm kernel char as source of heat.

Weight of sinter product			
	A	B	C
Initial weight of sinter	1000	1000	1000
Retained weight of sinter at -0.5mm	40	47	52
% Abrasion Index	4.0%	4.7%	5.2%

$$\text{Average Abrasion Index} = \frac{4.0+4.7+5.2}{3} = 4.6\% \tag{9}$$

3. Porosity

Table 3:5 The result of the porosity Test using coke as source of heat.

Weight of sinter product			
	A	B	C
Initial weight of sinter	112	110	115
Soaked weight of sinter	120	116	124
Different in weight	8	6	9
% porosity	7.1%	5.4%	7.8%

$$\text{Average Porosity} = \frac{7.1+5.4+7.8}{3} = 6.77\% \tag{10}$$

Table 3:6 The result of the porosity Test using palm kernel char as source of heat.

Weight of sinter product			
	A	B	C
Initial weight of sinter	90	112	110
Soaked weight of sinter	96	118	118
Different in weight	6	6	8
% porosity	6.7%	5.4%	7.3%

$$\text{Average Porosity} = \frac{6.7+5.4+7.3}{3} = 6.5\% \tag{11}$$

The tumbler index range percentage of 88wt% -93wt% was significantly higher than the stipulated between 60-70 wt.%. For the use of coke and palm kernel char to sinter, the result obtained for the tumbler test was at the rate of 70.2% and 65.7%, were by stipulated results. As the abrasion index of sinter fall between the range of 0.54 - 3.41wt% term to be lower than the acceptable abrasion limit (5wt%), the abrasion index test result has 5.1% and 4.6% using the same fuel as a source of heat respectively, (2). The porosity test was in the range of 5.1% to 9.82% exhibits quality sinter. Therefore, the result from the sintering process using coke and palm kernel char as a fuel shows the results of porosity 6.77% and 6.5%(9). With these results gathered, the sinter can be handled, loaded, and transported without disintegration to a small particle. However, the developed iron ores sintering machine has better efficiency of producing sinter for blast furnace operation.

4. CONCLUSIONS

In this study, development of iron ores sintering system for blast furnace process was successfully achieved. However, the possibility of producing sinters for blast furnace feeding was attained by designing, fabricating and tested to determine the performance evaluation of the machine and its effectiveness. In this work, coke and palm kernel char were used as a source of fuel in the sintering process, as tumbler index, abrasion index, and porosity test of the sinters product were evaluated. The result of Tumbler Index using coke and palm kernel char as a source of fuel were 70.2% and 65.7% respectively. Moreover, the abrasion index test result using the same source of fuel for the sintering process was achieved at a rate of 5.1% and 4.6% respectively. The best significance porosity result test was also attained at the level of 6.77% and 6.5% respectively. However, the performance evaluation results obtained from this research work were compared with other similar work done by other researchers. The comparison of the result showed that the sinters product were of good quality. The machine was developed and fabricated from locally sourced materials which make it cheaper and affordable for both small and medium scale for miners in local areas. However, the developed iron ore sintering machine is about 99% cheaper in price as compared to imported iron ore sintering machine. Finally, this machine requires little or no expertise or training for its operation and maintenance.

The machine for sintering Iron ore was successfully developed to produce quality sinters with the use of coke and palm kernel char as source of heat for the sintering of the iron ore with a reduced cost. However, the further research work can also be carried out in the area of using charcoal and other Agro-waste materials as source of heat, instead of making use of Liquefied Petroleum Gas (LPG), Diesel Burner and Blower.

REFERENCES

- [1]. Abhishek. M., (2015): "Sintering of Iron Ore". Project and Seminar Pp 5 – 6.
- [2]. Abraham. J.B.M., Andrey. V.K., Joseph. K.B., and Par. G.J., (2012): "Characterisation of the physical and metallurgical properties of Natural Iron Ore for Production", ISRN Material Science, Vol 2012, Pp 1 – 2.
- [3]. Ajaka. E. O., Adesina. A. E., and Lawal A. I., (2015): "Determination of the Optimum Conditions for Beneficiation of Selected Nigerian Iron Ores using Shaking Table". Annals of Faculty Engineering Hundoara, International Journal of Engineering, Pp 207.
- [4]. Arikata. Y., Yamamoto. K., and Sassa. Y., (2013): "Effect of Coke Breeze Addition Timing on Sintering Operation." ISIJ International, 53, Pp. 1523–1528
- [5]. Cores. A., Verdeja. I. F., Ferreira. S., Ruiz-Bustinza. I., and Mochón. J., (2013): "Iron Ore Sintering. Part I. Theory and Practice of the Sintering Process." DYNA Colombia, 80, Pp. 152–171.
- [6]. De la Torre. L., (2011): Natural Resources Sustainability: Iron Ore Mining. DYNA, Vol. 78, Pp. 227-234,
- [7]. Fernandez-Gonzalez. D.R, Ruiz- Bustinza. I, Mochon. J, Gonzalez-Casca. C, and Verdeja, L.F., (2017): "Iron Ore Sintering: Raw Materials and Granulation". Mineral Processing and Extractive Metallurgy Review 38, Pp. 36 – 46.
- [8]. Legemza. J., Fröhlichová. M., Findorák. R., Bakaj. F., (2010): The thermovision measurement of temperature in the iron-oresintering process with the biomass, Acta Metallurgica Slovaca1, 70-75.
- [9]. Ma. X., Bruckard. W. J., Holmes. R. J., (2009): Effect of collector,pH and ionic strength on the cationic flotation of kaolinite, International Journal of Mineral Processing 93, 54-58.